

180 x 40 x 30 cm

70.9" x 15.7" x 11.8"

KIT SIMONBOTTLE 3-400



5 Años Garantía
Years Guarantee
Jahre Garantie
Ans Garantie
Anos de Garantía

SIMONRACK



*MEDIDAS EN USO • USED MEASUREMENTS
MASSNAHMEN IM EINSATZ • MESURES EN EMPLOI • MEDIDAS EM USO:
1781 x 410 x 310 mm (70.12 x 16.14 x 12.20")



ESTANTERIAS SIMON S.L. B.50.556.463
PG. ALFAMEN C/ POLIGONO C, Nº3
ALFAMEN (ZARAGOZA)







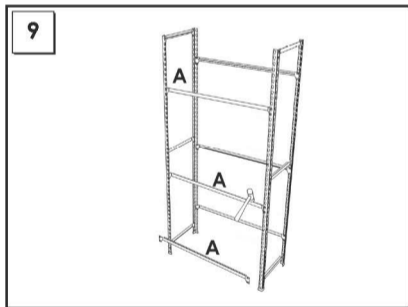
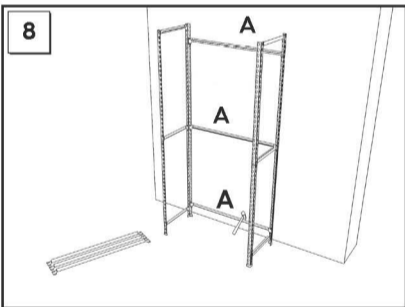
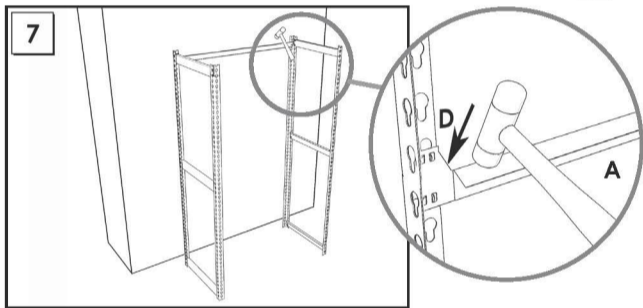
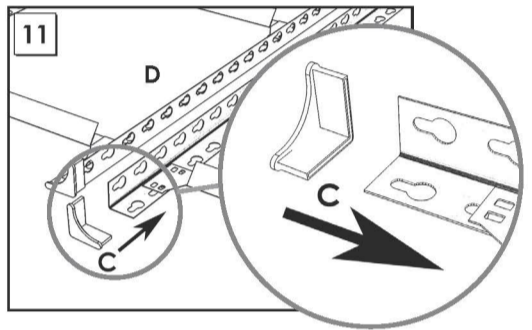
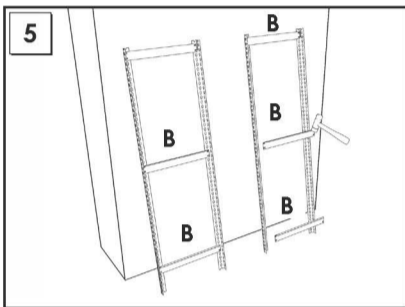
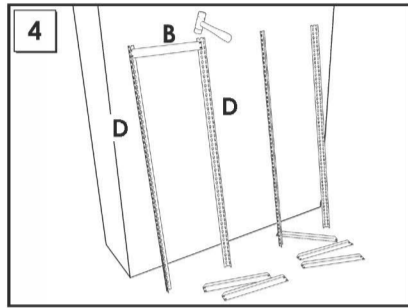
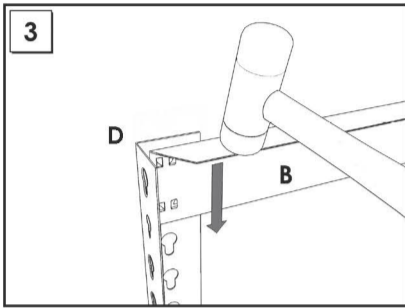
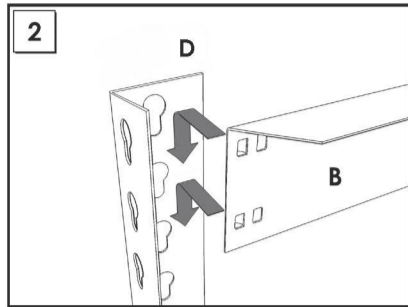
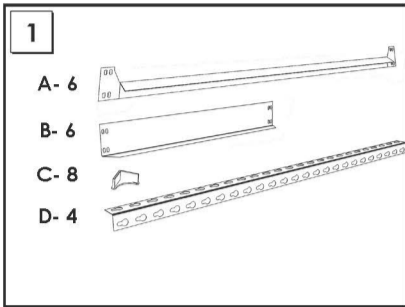





Simon
Rack
SINCE 1964 - MANUFACTURER
www.simonrack.com



INSTRUCCIONES
INSTRUCTIONS
ANLEITUNG
INSTRUCTIONS



www.simonrack.com • www.simonrack.com • www.simonrack.com • www.simonrack.com

SIMONCLASSIC	SIMONCLICK	SIMONTALLER	SIMONAUTO
 <p>✓ 150 kg 350 lb</p>	 <p>✗ 400 kg 900 lb</p>	 <p>✗ 700 kg 1550 lb</p>	 <p>✗ 300 kg 660 lb</p>
SIMONWORK	SIMONLOCKER	SIMONOFFICE	SIMONHOME
 <p>✗ 800 kg 1800 lb</p>	 <p>✗ ✗</p>	 <p>✗ 275 kg 600 lb</p>	 <p>✗ 150 kg 350 lb</p>
SIMONGARDEN	SIMONTITAN	SIMONINOX	SIMONINDUSTRIAL
 <p>✗ 600 kg 1350 lb</p>	 <p>✗ 900 kg 1990 lb</p>	 <p>✗</p>	 <p>SIMONPALET 4500 kg 9950 lb</p> <p>SIMONLEVER</p> <p>ALTILLOS Y PASILLOS ELEVADOS • PLATFORMS AND MEZZANINES • LAGERBUHNIEN • PLATES- FORMES ET MEZZANINES</p>