

180 x 80 x 30 cm

70.9" x 31.5" x 11.8"

KIT SIMONBOTTLE 3-800



300 kg
(660 lb)
Total

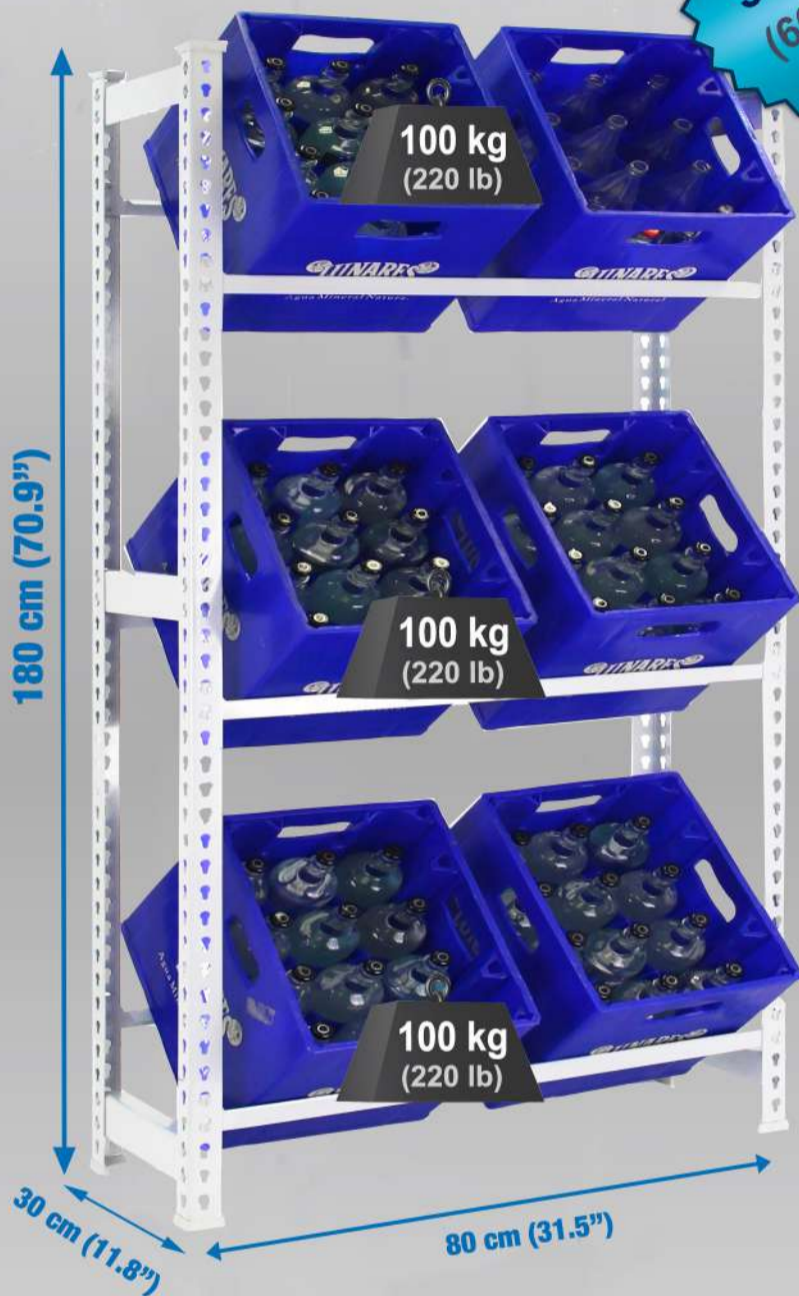

*MEDIDAS EN USO • USED MEASUREMENTS
MASSNAHMEN IM EINSATZ • MESURES EN EMPLOI • MEDIDAS EM USO:
1781 x 810 x 310 mm (70.12 x 31.88 x 12.20")









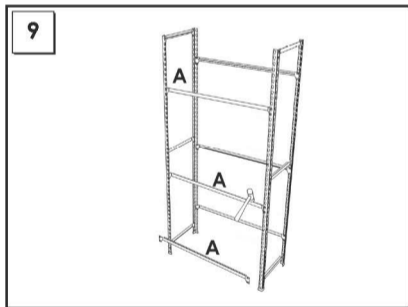
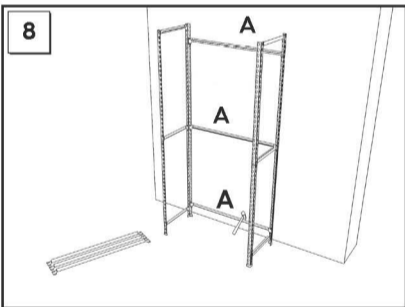
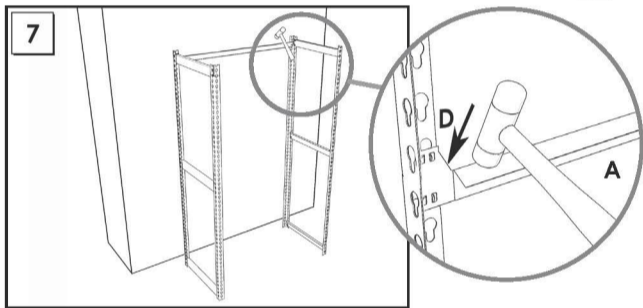
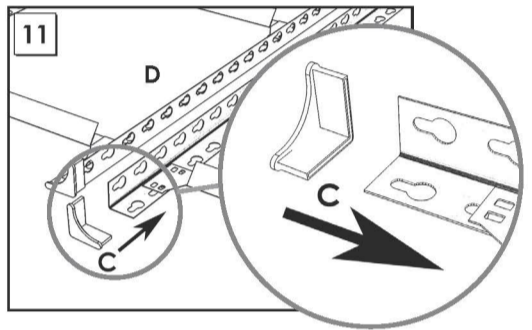
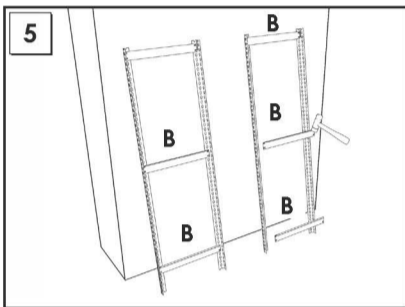
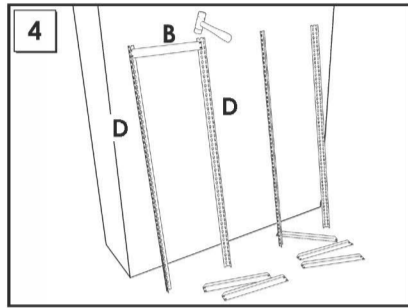
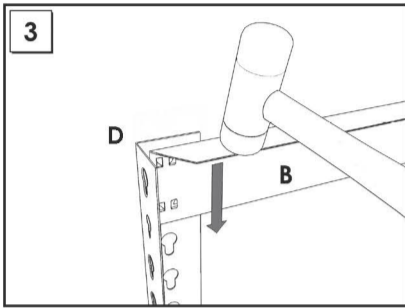
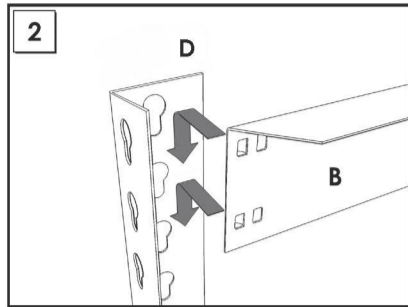
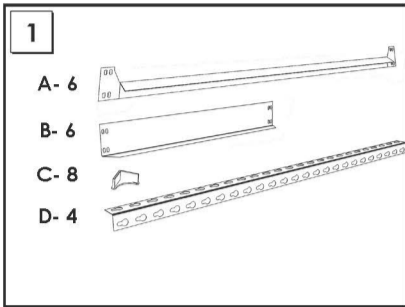





ESTANTERIAS SIMON S.L. B.50.556.463
PG. ALFAMEN C/ POLIGONO C, Nº3
ALFAMEN (ZARAGOZA)



INSTRUCCIONES
INSTRUCTIONS
ANLEITUNG
INSTRUCTIONS



www.simonrack.com • www.simonrack.com • www.simonrack.com • www.simonrack.com

SIMONCLASSIC	SIMONCLICK	SIMONTALLER	SIMONAUTO
 <ul style="list-style-type: none"> ✓ 150 kg 350 lb 	 <ul style="list-style-type: none"> ✗ 400 kg 900 lb 	 <ul style="list-style-type: none"> ✗ 700 kg 1550 lb 	 <ul style="list-style-type: none"> ✗ 300 kg 660 lb
SIMONWORK	SIMONLOCKER	SIMONOFFICE	SIMONHOME
 <ul style="list-style-type: none"> ✗ ✓ 800 kg 1800 lb 	 <ul style="list-style-type: none"> ✗ ✗ 	 <ul style="list-style-type: none"> ✗ 275 kg 600 lb 	 <ul style="list-style-type: none"> ✗ ✓ 150 kg 350 lb
SIMONGARDEN	SIMONTITAN	SIMONINOX	SIMONINDUSTRIAL
 <ul style="list-style-type: none"> ✗ ✓ 600 kg 1350 lb 	 <ul style="list-style-type: none"> ✗ 900 kg 1990 lb 	 <ul style="list-style-type: none"> ✗ 	 <ul style="list-style-type: none"> 4500 kg 9950 lb

ALTILLOS Y PASILLOS
ELEVADOS • PLATFORMS
AND MEZZANINES •
LAGERBUHLEN • PLATES-
FORMES ET MEZZANINES