

180 x 100 x 30 cm

70.9" x 39.4" x 11.8"

KIT SIMONBOTTLE 3-1000



*MEDIDAS EN USO • USED MEASUREMENTS
 MASSNAHMEN IM EINSATZ • MESURES EN EMPLOI • MEDIDAS EM USO:
 1781 x 1010 x 310 mm (70.12 x 39.78 x 12.20")









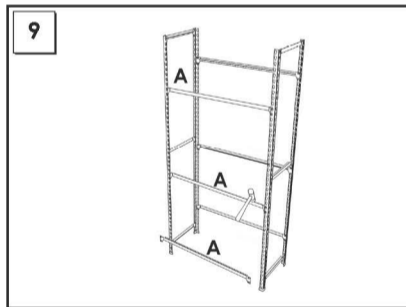
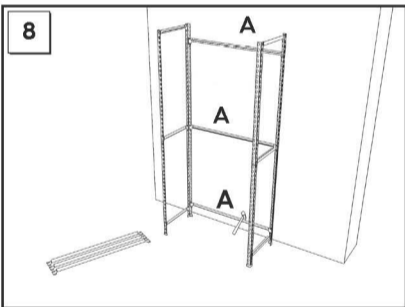
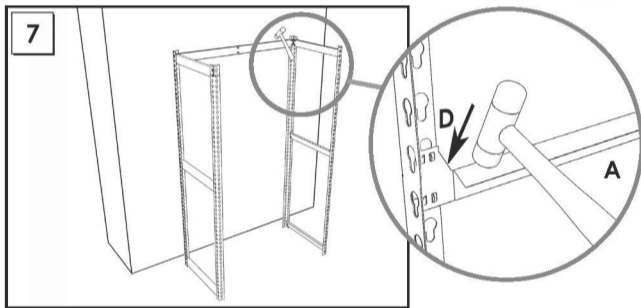
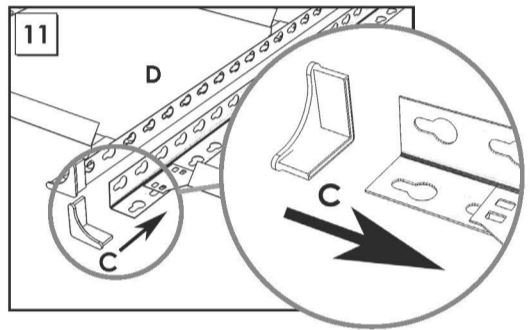
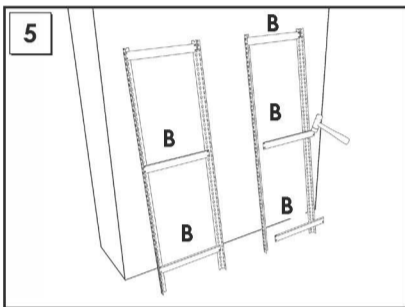
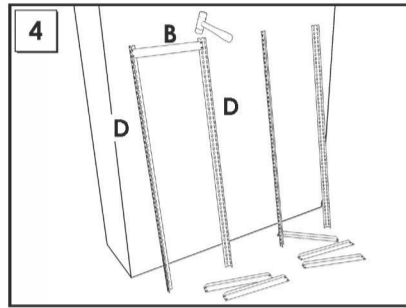
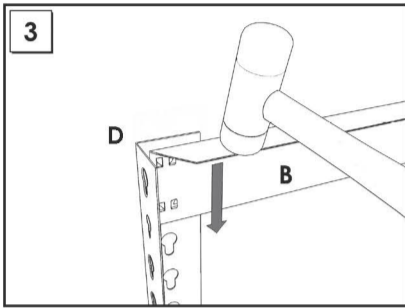
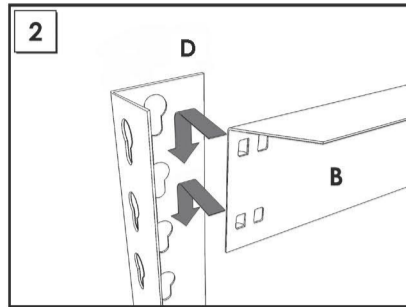
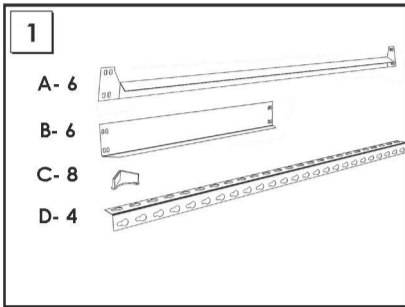





ESTANTERIAS SIMON S.L. B.50.556.463
 PG. ALFAMEN C/ POLIGONO C, Nº3
 ALFAMEN (ZARAGOZA)



INSTRUCCIONES
 INSTRUCTIONS
 ANLEITUNG
 INSTRUCTIONS



www.simonrack.com • www.simonrack.com • www.simonrack.com • www.simonrack.com

SIMONCLASSIC	SIMONCLICK	SIMONTALLER	SIMONAUTO
 <p>✓ 150 kg 350 lb</p>	 <p>✗ 400 kg 900 lb</p>	 <p>✗ 700 kg 1550 lb</p>	 <p>✗ 300 kg 660 lb</p>
SIMONWORK	SIMONLOCKER	SIMONOFFICE	SIMONHOME
 <p>✗ 800 kg 1800 lb</p>	 <p>✗ ✗</p>	 <p>✗ 275 kg 600 lb</p>	 <p>✗ 150 kg 350 lb</p>
SIMONGARDEN	SIMONTITAN	SIMONINOX	SIMONINDUSTRIAL
 <p>✗ 600 kg 1350 lb</p>	 <p>✗ 900 kg 1990 lb</p>	 <p>✗</p>	<p>SIMONPALET SIMONLEVER</p>  <p>4500 kg 9950 lb</p> <p>ALTILLOS Y PASILLOS ELEVADOS • PLATFORMS AND MEZZANINES • LAGERBUHLEN • PLATES- FORMES ET MEZZANINES</p>