

# 180 x 80 x 30 cm

## 70.9" x 31.5" x 11.8"

### KIT SIMONBOTTLE 3-800



**5** Años Garantía  
Years Guarantee  
Jahre Garantie  
Ans Garantie  
Anos de Garantia

**SIMONRACK**

**300 kg**  
(660 lb)  
**Total**

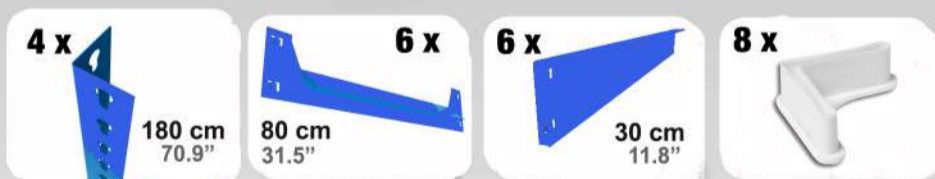

\*MEDIDAS EN USO • USED MEASUREMENTS  
MASSNAHMEN IM EINSATZ • MESURES EN EMPLOI • MEDIDAS EM USO:  
1781 x 810 x 310 mm (70.12 x 31.88 x 12.20")



ESTANTERIAS SIMON S.L. B.50.556.463  
PG. ALFAMEN C/ POLIGONO C, Nº3  
ALFAMEN (ZARAGOZA)







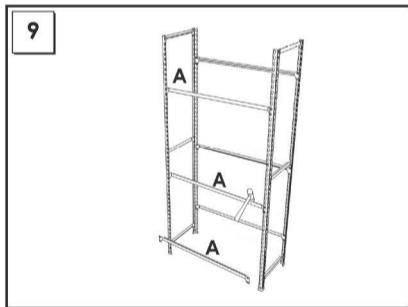
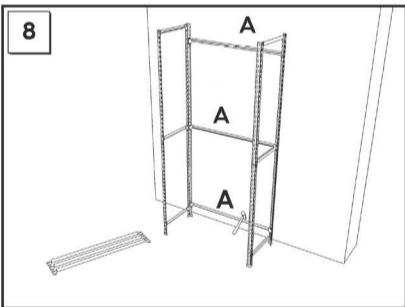
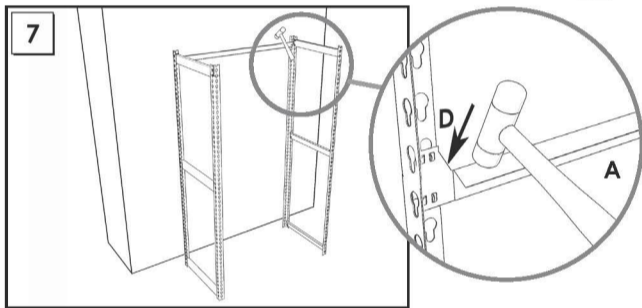
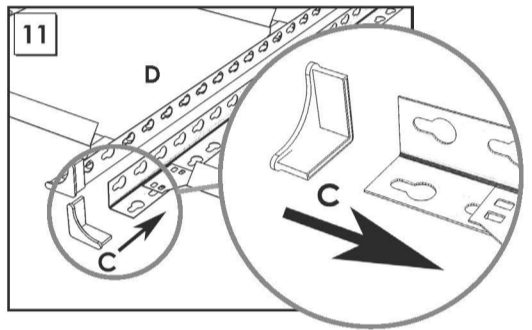
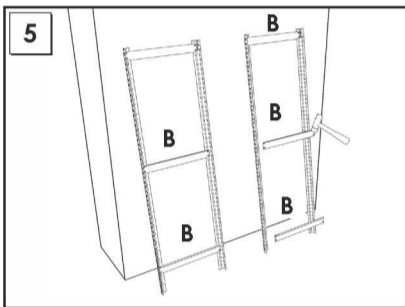
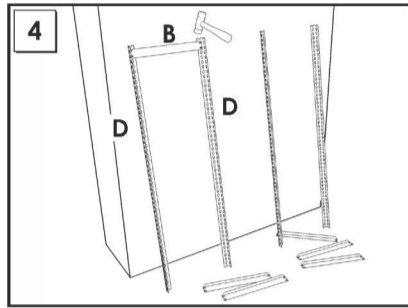
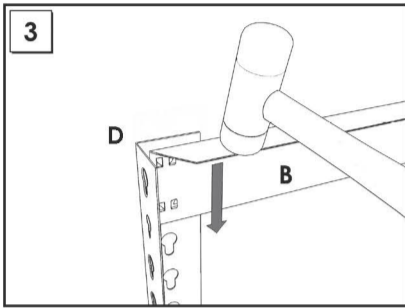
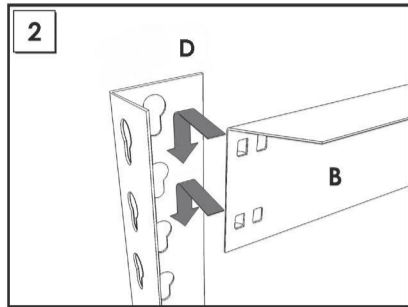
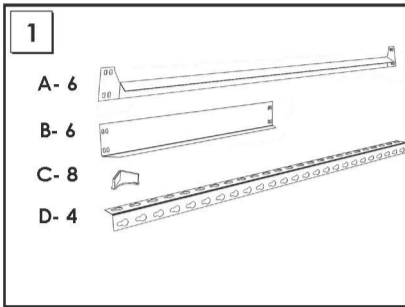



**Simon**  
**Rack**  
SINCE 1964 - MANUFACTURER  
[www.simonrack.com](http://www.simonrack.com)



INSTRUCCIONES  
INSTRUCTIONS  
ANLEITUNG  
INSTRUCTIONS

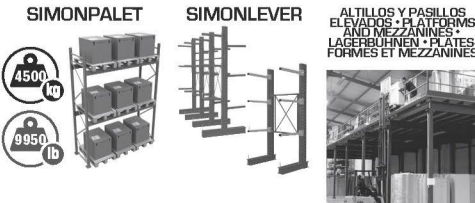

www.simonrack.com • www.simonrack.com • www.simonrack.com • www.simonrack.com

SIMONCLASSIC	SIMONCLICK	SIMONTALLER	SIMONAUTO
 <p>✓ 150 kg 350 lb</p>	 <p>✗ 400 kg 900 lb</p>	 <p>✗ 700 kg 1550 lb</p>	 <p>✗ 300 kg 660 lb</p>
SIMONWORK	SIMONLOCKER	SIMONOFFICE	SIMONHOME
 <p>✗ 800 kg 1800 lb</p>	 <p>✗ ✗</p>	 <p>✗ 275 kg 600 lb</p>	 <p>✗ 150 kg 350 lb</p>
SIMONGARDEN	SIMONTITAN	SIMONINOX	SIMONINDUSTRIAL
 <p>✗ 600 kg 1350 lb</p>	 <p>✗ 900 kg 1990 lb</p>	 <p>✗</p>	<p>SIMONPALET SIMONLEVER</p>  <p>4500 kg 9950 lb</p> <p>ALTILLOS Y PASILLOS ELEVADOS • PLATFORMS AND MEZZANINES • LAGERBUHLEN • PLATES- FORMES ET MEZZANINES</p>