

180 x 40 x 30 cm

70.9" x 15.7" x 11.8"

KIT SIMONBOTTLE 3-400



5 Años Garantía
Years Guarantee
Jahre Garantie
Ans Garantie
Anos de Garantia
SIMONRACK

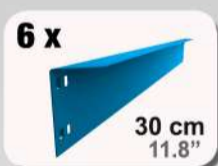
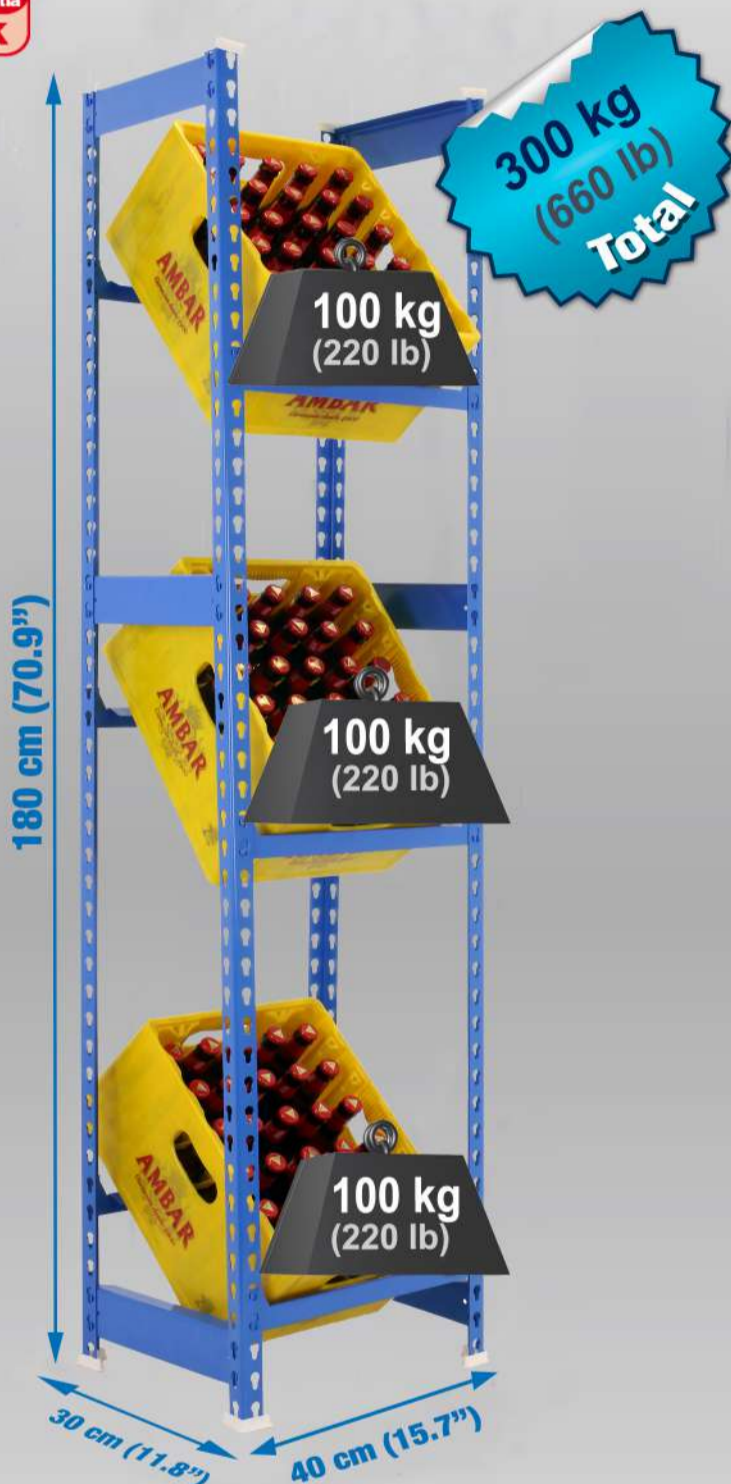

*MEDIDAS EN USO • USED MEASUREMENTS
MASSNAHMEN IM EINSATZ • MESSUREN EN EMPLOIO • MEDIDAS EM USO:
1781 X 410 X 310 mm (70.12" x 16.14 x 12.20")



ESTANTERIAS SIMON S.L. B.50.556.463
PG. ALFAMEN C/ POLIGONO C, Nº3
ALFAMEN (ZARAGOZA)







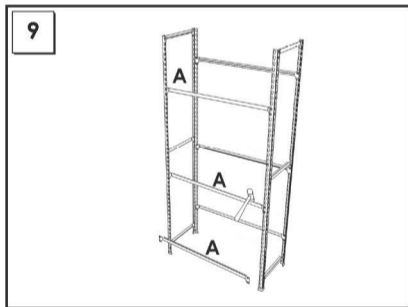
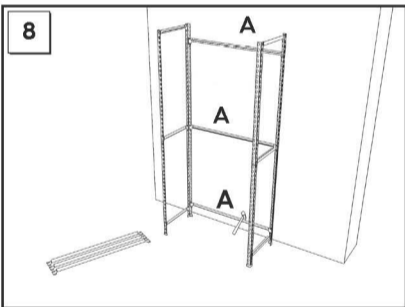
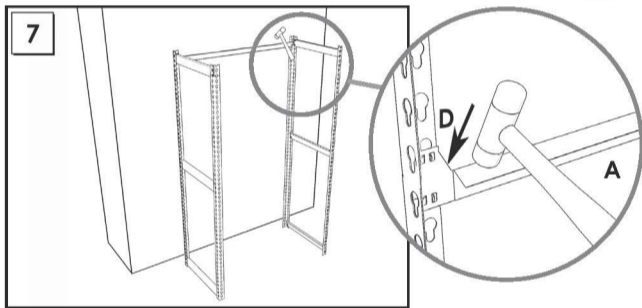
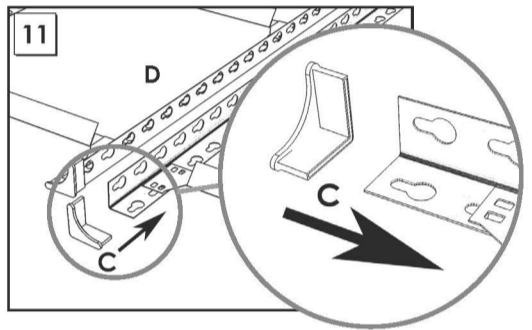
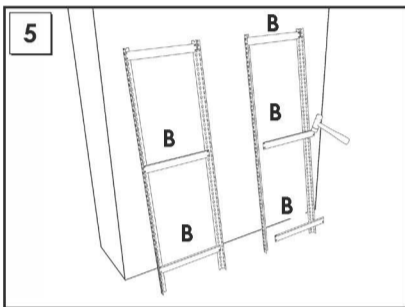
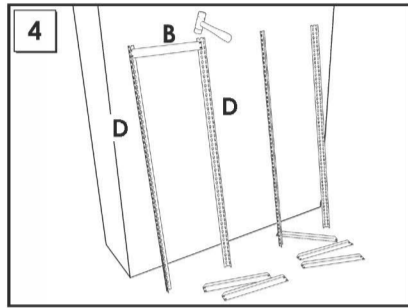
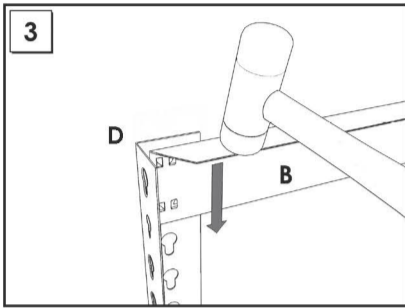
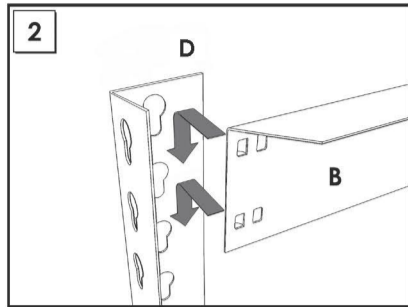
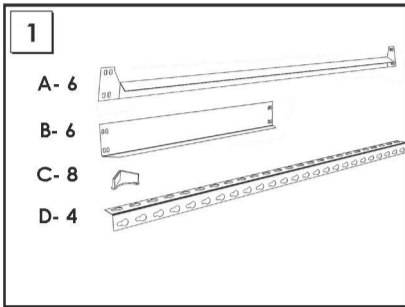





Simon
Rack
SINCE 1964 - MANUFACTURER
www.simonrack.com



INSTRUCCIONES
INSTRUCTIONS
ANLEITUNG
INSTRUCTIONS



www.simonrack.com • www.simonrack.com • www.simonrack.com • www.simonrack.com

| SIMONCLASSIC | SIMONCLICK | SIMONTALLER | SIMONAUTO |
|--|--|--|---|
|  <ul style="list-style-type: none"> ✓ 150 kg 350 lb |  <ul style="list-style-type: none"> ✗ 400 kg 900 lb |  <ul style="list-style-type: none"> ✗ 700 kg 1550 lb |  <ul style="list-style-type: none"> ✗ 300 kg 660 lb |
| SIMONWORK | SIMONLOCKER | SIMONOFFICE | SIMONHOME |
|  <ul style="list-style-type: none"> ✗ 800 kg 1800 lb |  <ul style="list-style-type: none"> ✗ ✗ |  <ul style="list-style-type: none"> ✗ 275 kg 600 lb |  <ul style="list-style-type: none"> ✗ 150 kg 350 lb |
| SIMONGARDEN | SIMONTITAN | SIMONINOX | SIMONINDUSTRIAL |
|  <ul style="list-style-type: none"> ✗ 600 kg 1350 lb |  <ul style="list-style-type: none"> ✗ 900 kg 1990 lb |  <ul style="list-style-type: none"> ✗ |  <ul style="list-style-type: none"> 4500 kg 9950 lb |

ALTILLOS Y PASILLOS
ELEVADOS • PLATFORMS
AND MEZZANINES •
LAGERBUHLEN • PLATES-
FORMES ET MEZZANINES