

# 100 x 100 x 30 cm

## 39.4" x 39.4" x 11.8"

### KIT SIMONBOTTLE 2



**5** Años Garantía  
Years Guarantee  
Jahre Garantie  
Ans Garantie  
Anos de Garantia

**SIMONRACK**

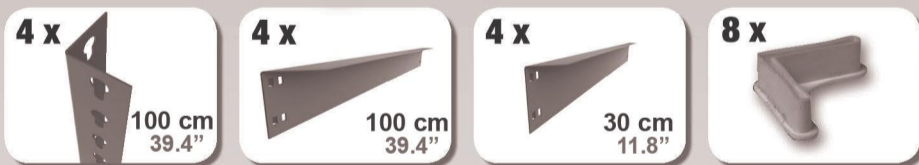

ESTANTERIAS SIMON S.L. B.50.556.463  
PG. ALFAMEN C/ POLIGONO C, Nº3  
ALFAMEN (ZARAGOZA)







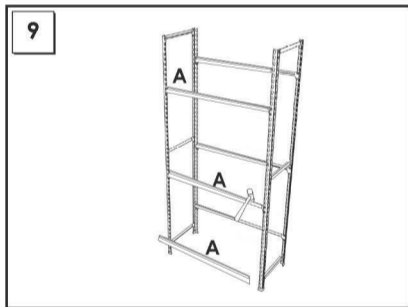
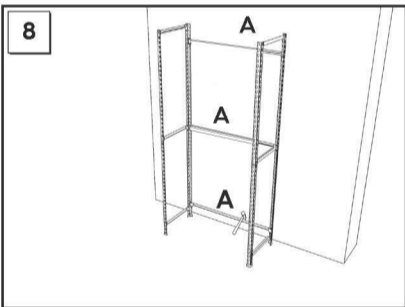
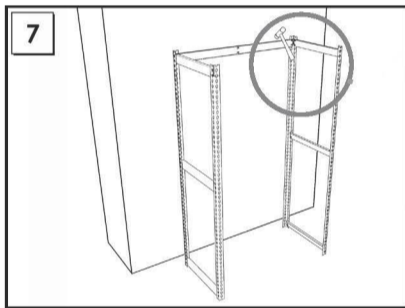
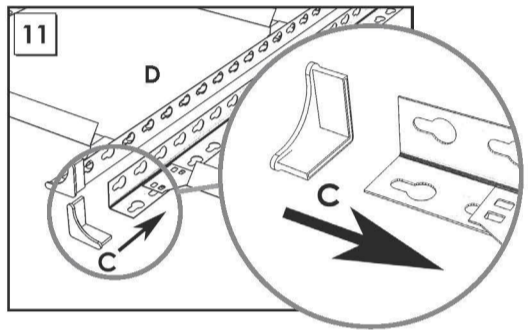
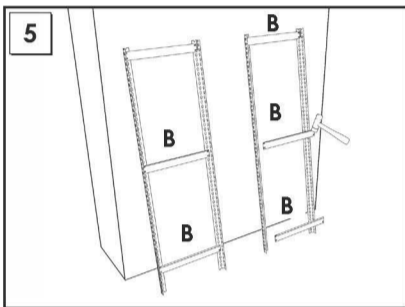
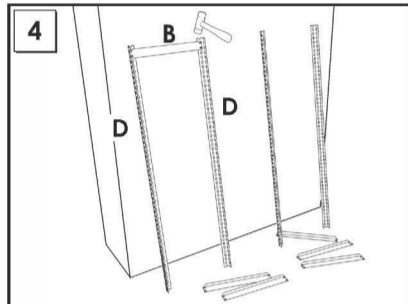
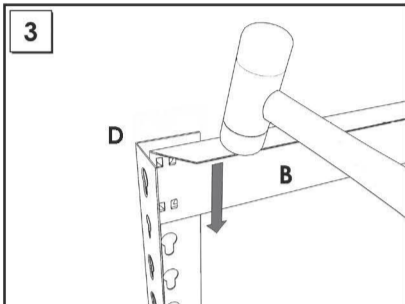
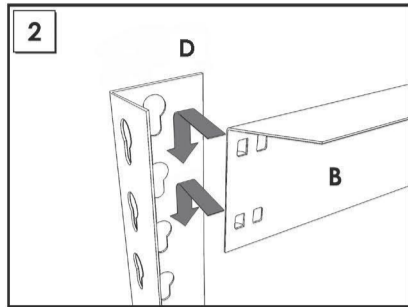
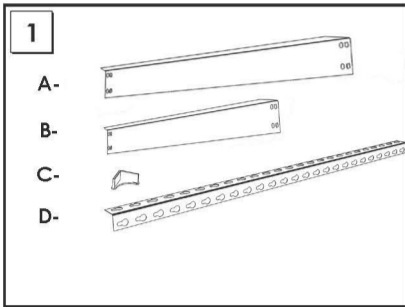





**Simon**  
**Rack**  
SINCE 1964 - MANUFACTURER  
[www.simonrack.com](http://www.simonrack.com)



INSTRUCCIONES  
INSTRUCTIONS  
ANLEITUNG  
INSTRUCTIONS



www.simonrack.com • www.simonrack.com • www.simonrack.com • www.simonrack.com

SIMONCLASSIC	SIMONCLICK	SIMONTALLER	SIMONAUTO
 <p>✓ 150 kg 350 lb</p>	 <p>✗ 400 kg 900 lb</p>	 <p>✗ 700 kg 1550 lb</p>	 <p>✗ 300 kg 660 lb</p>
SIMONWORK	SIMONLOCKER	SIMONOFFICE	SIMONHOME
 <p>✗ 800 kg 1800 lb</p>	 <p>✗ ✗</p>	 <p>✗ 275 kg 600 lb</p>	 <p>✗ 150 kg 350 lb</p>
SIMONGARDEN	SIMONTITAN	SIMONINOX	SIMONINDUSTRIAL
 <p>✗ 600 kg 1350 lb</p>	 <p>✗ 900 kg 1990 lb</p>	 <p>✗</p>	<p>SIMONPALET</p>  <p>4500 kg 9950 lb</p> <p>SIMONLEVER</p>  <p>ALTILOS Y PASILLOS ELEVADOS • PLATFORMS AND MEZZANINES • LAGERBUHLEN • PLATES- FORMES ET MEZZANINES</p> 