

SIMONWORK BT3 BOX 1500

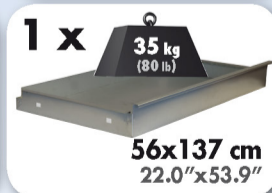

144,5 x 151 x 61 cm
56.9" x 59.4" x 24.0"

5 Años Garantía
 Years Guarantee
 Jahre Garantie
 Ans Garantie
SIMONRACK

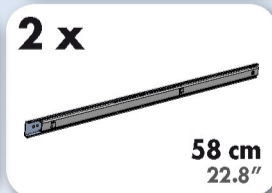
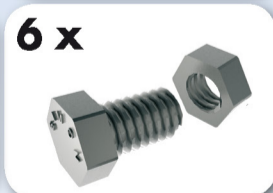
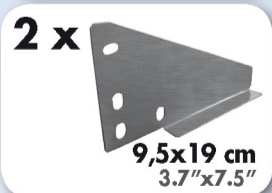
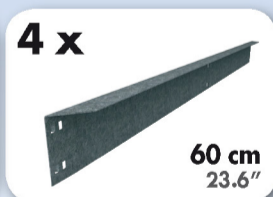
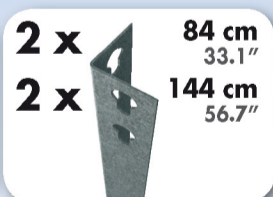
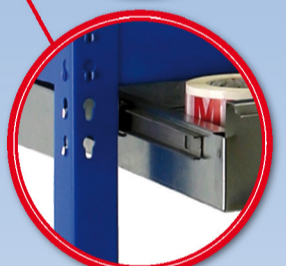
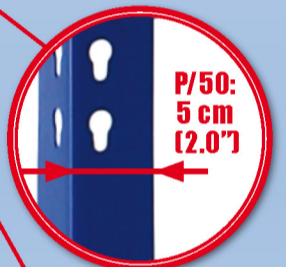
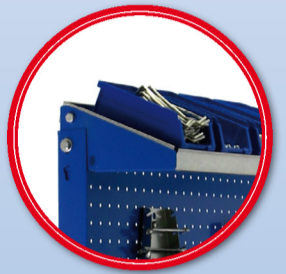
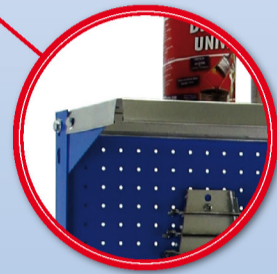

ESTANTERIAS SIMON S.L. B.50.556.463
 PG. ALFAMEN C/ POLIGONO C. Nº3
 ALFAMEN (ZARAGOZA)



www.simonrack.com



INSTRUCCIONES
 INSTRUCTIONS
 ANLEITUNG
 INSTRUCTIONS

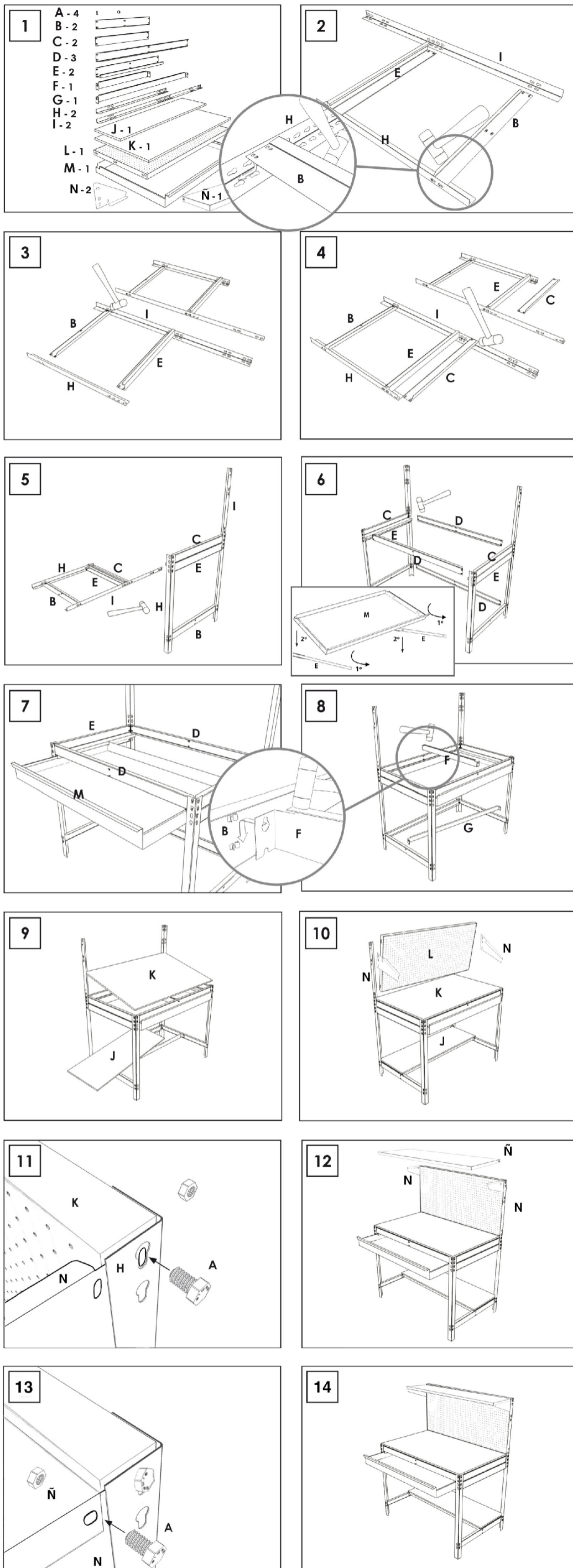

SIMONCLASSIC

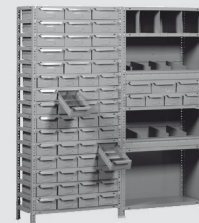

SIMONCLICK



SIMONTALLER



SIMONAUTO



SIMONWORK



SIMONLOCKER



SIMONOFFICE



SIMONHOME



SIMONGARDEN

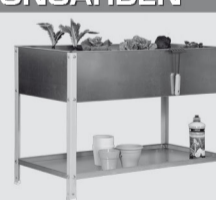
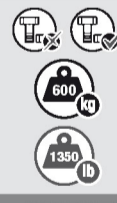

SIMONTITÁN

SIMONINOX



SIMONINDUSTRIAL

SIMONPALET

SIMONLEVER



ALTILLOS Y PASILLOS ELEVADOS
PLATFORMS AND MEZZANINES
LAGERBÜHNEN • PLATES-FORMES ET MEZZANINES



* Kg / lb por bandeja con carga uniformemente repartida
Kg / lb per shelf uniformly distributed load
Kg / lb pro fach bei gleichmäßig verteilter Last
Kg / lb par plateau avec charge uniformément répartie

