

SIMONWORK BT3 1200

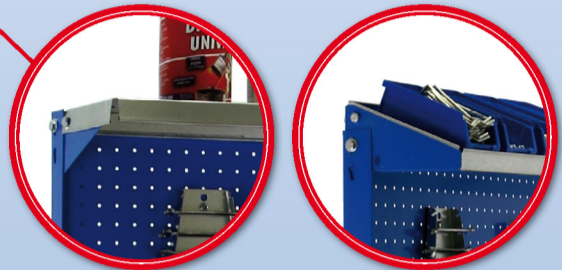

144,5 x 121 x 61 cm
56.9" x 47.6" x 24.0"

5 Años Garantía
 Years Guarantee
 Jahre Garantie
 Ans Garantie
SIMONRACK

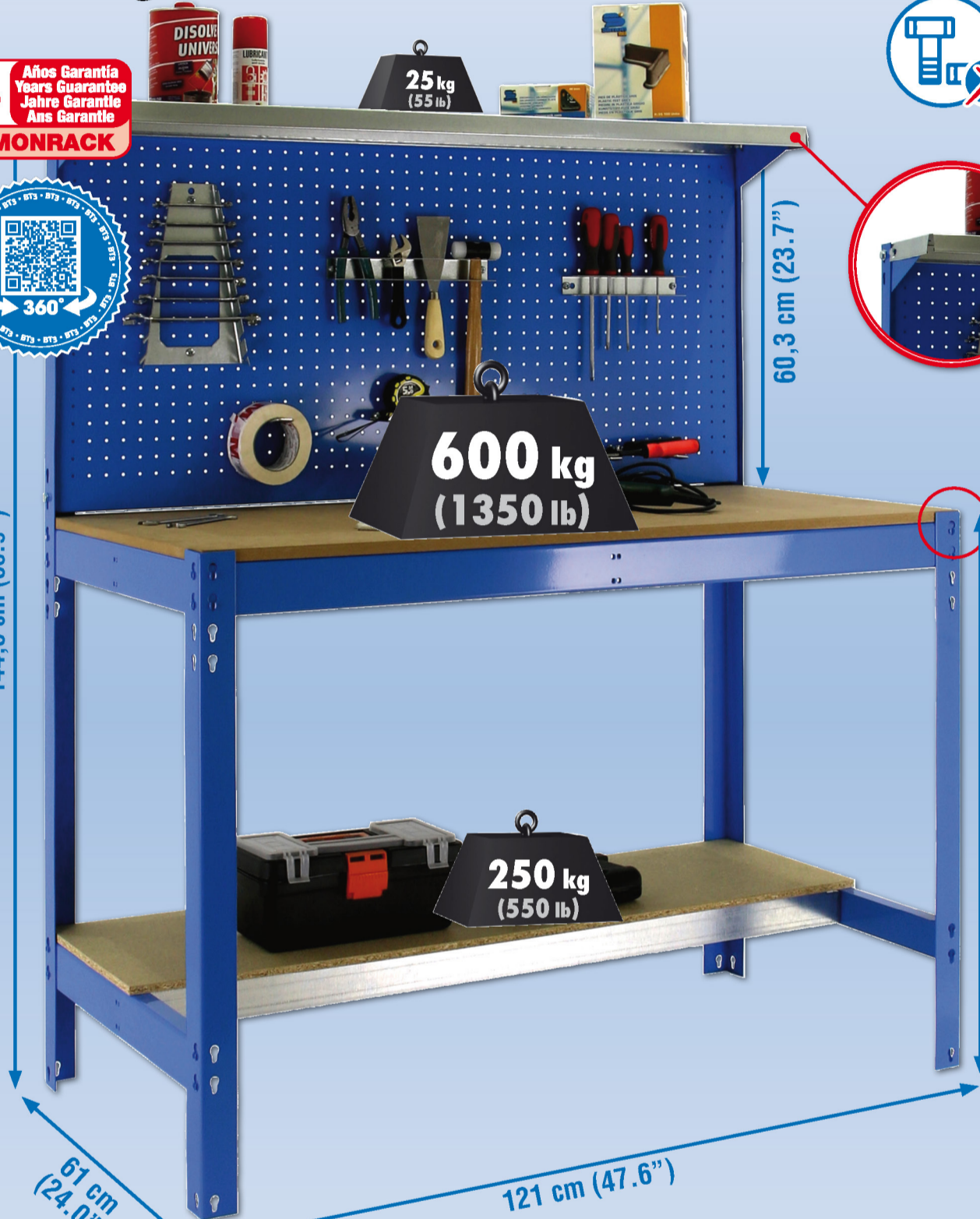

- 1 x 120x60 cm (47.2"x23.6")
- 2 x 84 cm (33.1") / 2 x 144 cm (56.7")
- 1 x MDF 60x120 cm (23.6"x47.2") / 1 x 35x120 cm (13.8"x47.2")
- 4 x 60 cm (23.6")
- 3 x 120 cm (47.2")
- 1 x 120 cm (47.2") / 1 x 60 cm (23.6")
- 2 x 9,5x19 cm (3.7"x7.5")
- 1 x 120x20 cm (47.2"x7.9")
- 6 x [Nut/Bolt]

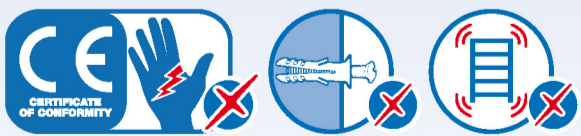

ESTANTERIAS SIMON S.L. B.50.556.463
 PG. ALFAMEN C/ POLIGONO C. Nº3
 ALFAMEN (ZARAGOZA)



www.simonrack.com



INSTRUCCIONES
 INSTRUCTIONS
 ANLEITUNG
 INSTRUCTIONS

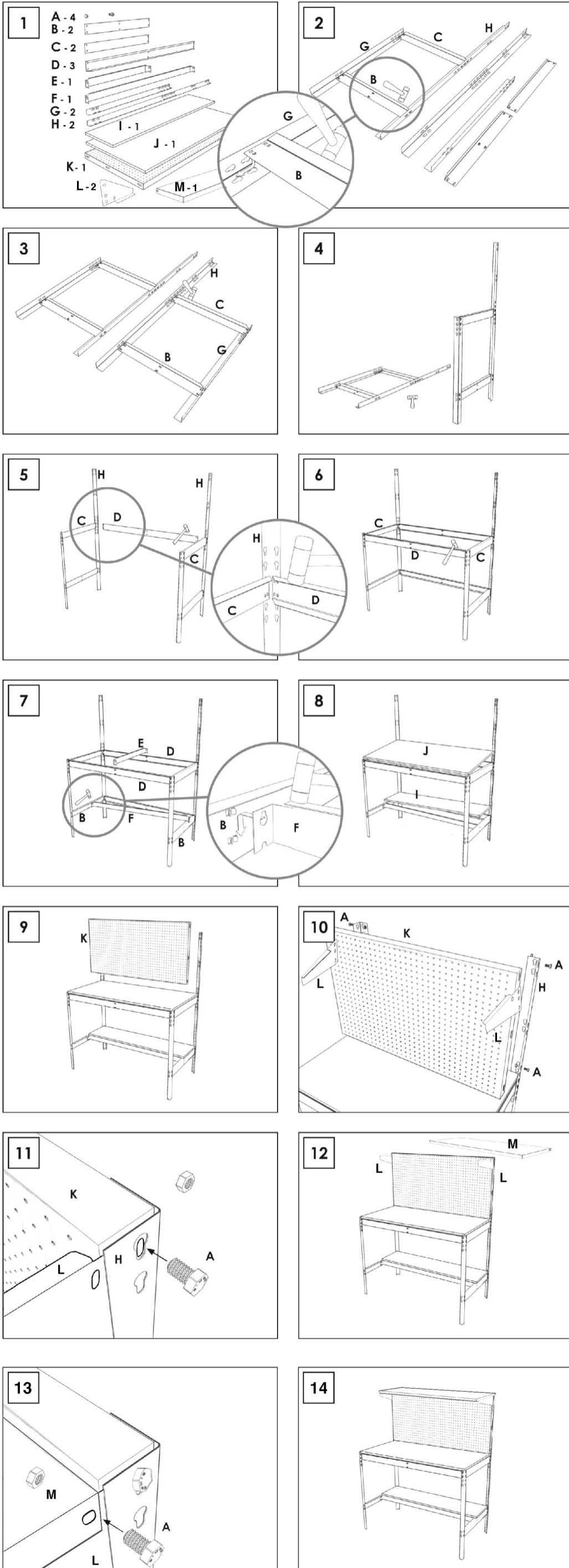

SIMONCLASSIC



SIMONCLICK



SIMONTALLER



SIMONAUTO



SIMONWORK



SIMONLOCKER

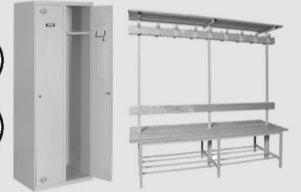

SIMONOFFICE



SIMONHOME



SIMONGARDEN



SIMONTITÁN



SIMONINOX



SIMONINDUSTRIAL

SIMONPALET

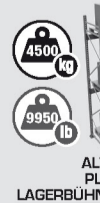

SIMONLEVER



ALTILLOS Y PASILLOS ELEVADOS
PLATFORMS AND MEZZANINES
LAGERBÜHNEN • PLATES-FORMES ET MEZZANINES

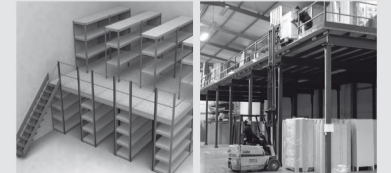

* Kg / lb per bandeja con carga uniformemente repartida
Kg / lb per shelf uniformly distributed load
Kg / lb pro fach bei gleichmäßig verteilter last
Kg / lb par plateau avec charge uniformément répartie