

SIMONWORK BT1 BOX 900



144,5 x 91 x 61 cm
56.9" x 35.8" x 24.0"



5 Años Garantía
 Years Guarantee
 Jahre Garantie
 Ans Garantie
SIMONRACK

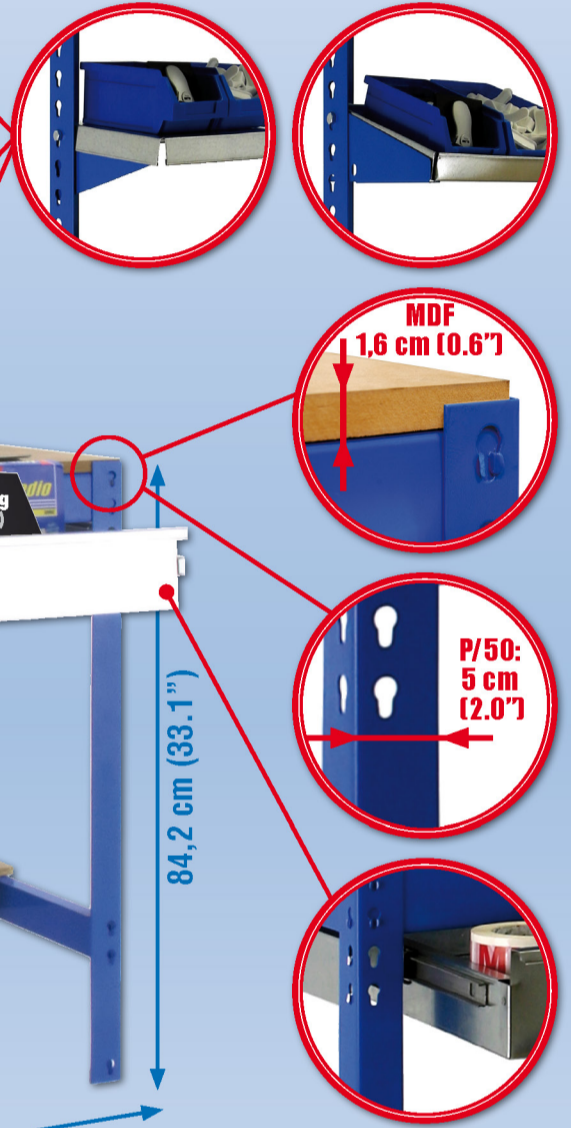
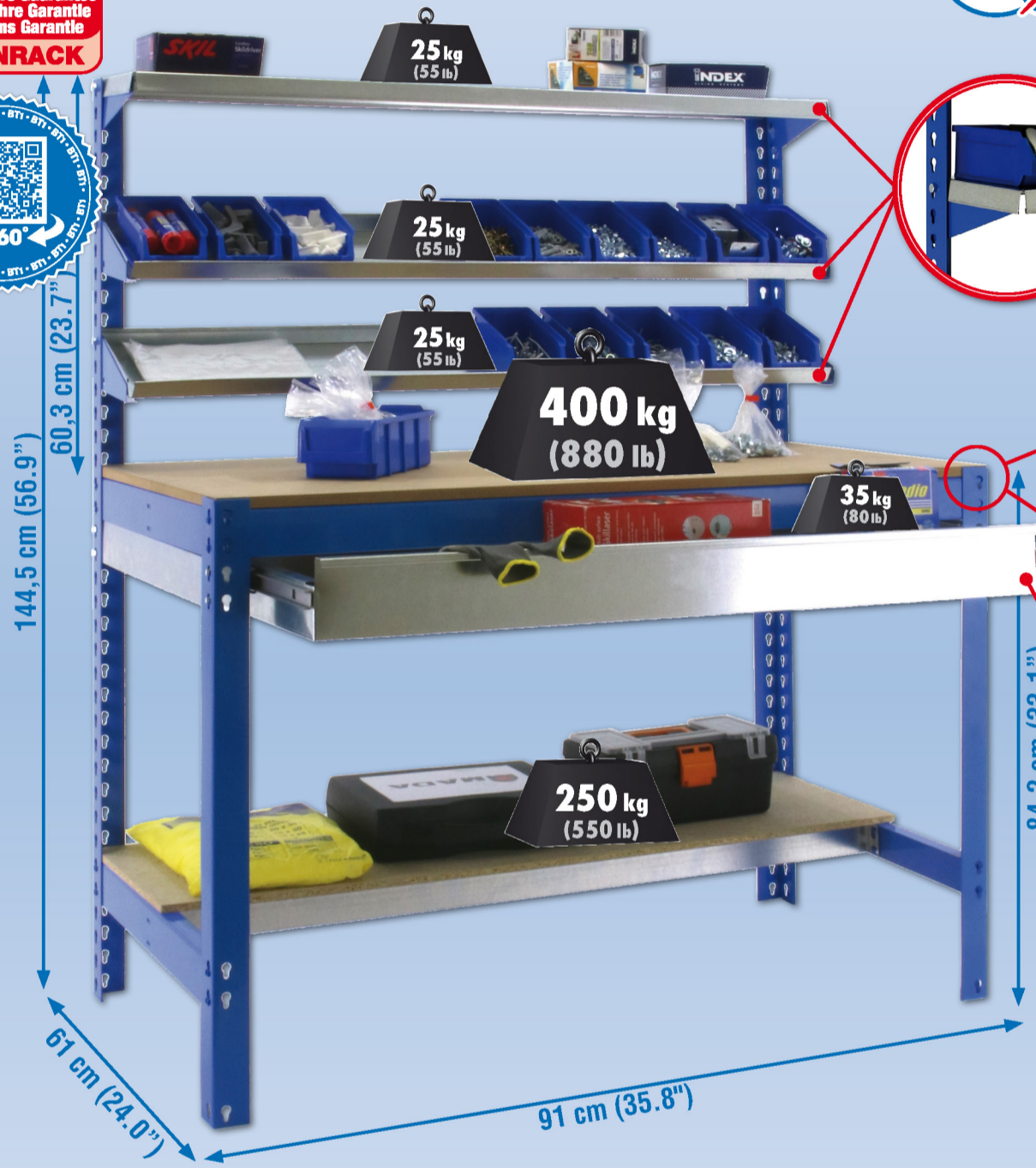

- 2 x 144 cm (56.7")
- 2 x 84 cm (33.1")
- 1 x MDF 60x90 cm (23.6"x35.4")
- 1 x 35x90 cm (13.8"x35.4")
- 3 x 90 cm (35.4")
- 4 x 60 cm (23.6")
- 6 x 9,5x19 cm (3.7"x7.5")
- 1 x 90 cm (35.4")
- 3 x 90x20 cm (35.4"x7.9")
- 6 x
- 2 x 60 cm (23.6")
- 2 x 58 cm (22.8")
- 1 x 35 kg (80 lb) 56x77 cm (22.0"x30.3")

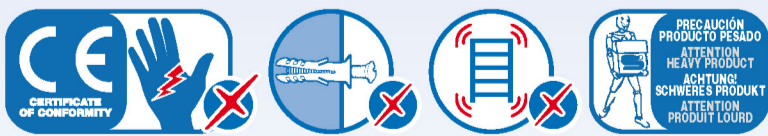

ESTANTERIAS SIMON S.L. B.50.556.463
 PG. ALFAMEN C/ POLIGONO C. Nº3
 ALFAMEN (ZARAGOZA)



www.simonrack.com



INSTRUCCIONES
 INSTRUCTIONS
 ANLEITUNG
 INSTRUCTIONS

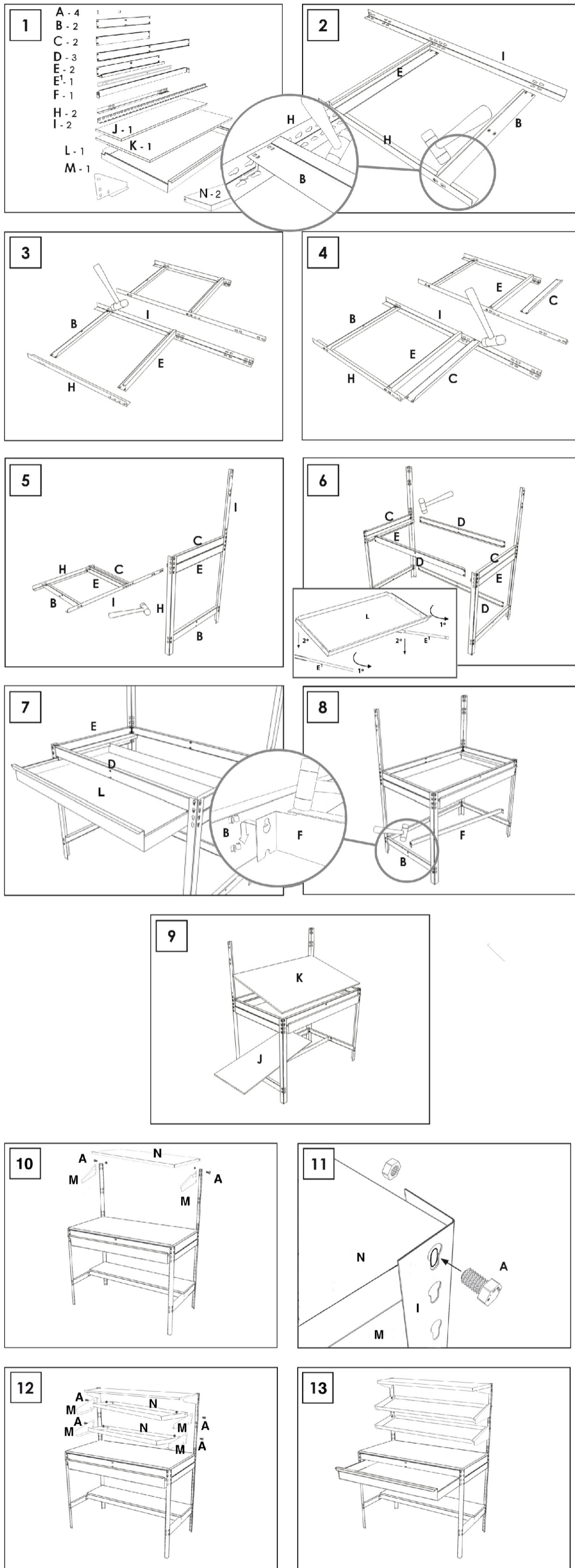

SIMONCLASSIC



SIMONCLICK



SIMONTALLER



SIMONAUTO

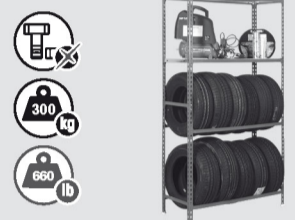

SIMONWORK

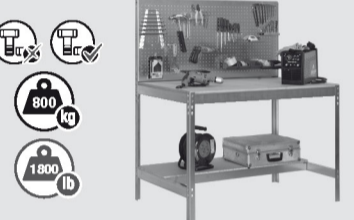

SIMONLOCKER



SIMONOFFICE



SIMONHOME

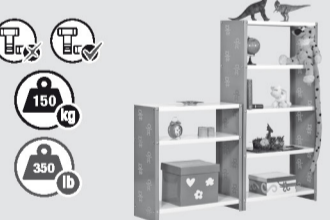

SIMONGARDEN



SIMONTITÁN

SIMONINOX



SIMONINDUSTRIAL

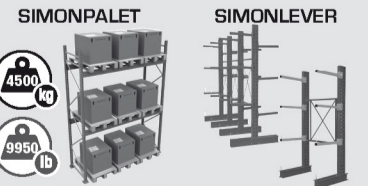

ALTILLOS Y PASILLOS ELEVADOS
PLATFORMS AND MEZZANINES
LAGERBÜHNEN • PLATES-FORMES ET MEZZANINES

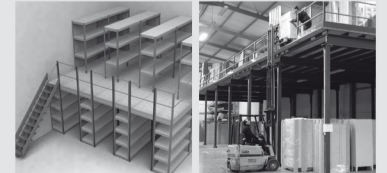

* Kg / lb por bandeja con carga uniformemente repartida
Kg / lb per shelf uniformly distributed load
Kg / lb pro fach bei gleichmäßig verteilter last
Kg / lb par plateau avec charge uniformément répartie

